

alessandradelgadoDESIGN

COLEÇÃO COMPLETA | COMPLETE COLLECTIONS

alessandra delgado DESIGN

Alessandra Delgado é arquiteta e há mais de 20 anos dedica-se ao design de móveis. A paixão pelas artes e arquitetura são inspiração para suas criações autorais, que reproduzem a experiência do traço apaixonado, atemporal e repleto de funcionalidade, heranças de sua formação.

Com diversas participações em exposições de design nacionais e internacionais, além de importantes premiações no segmento, suas criações exclusivas integram o portfólio de sua marca ALESSANDRA DELGADO DESIGN.

“Acredito que cada criação deve ser pensada para ter uma personalidade própria marcante e superar modismos, atravessando o tempo de forma única”.

Alessandra Delgado



Alessandra Delgado is an architect and has been dedicated to furniture design for over 20 years. Her passion for the arts and architecture are the inspiration for her authorial creations, which reproduce the experience of the passionate, timeless and functional trait, inheritances of her training. With several participations in national and international design exhibitions, as well as important awards in the segment, her exclusive creations are part of the portfolio of her brand ALESSANDRA DELGADO DESIGN.

"I believe that each creation must be designed to have its own striking personality and overcome fads, crossing time in a unique way".

Alessandra Delgado

A ALESSANDRA DELGADO DESIGN tem soluções customizadas para seus projetos.

Nossa coleção completa de produtos é composta por uma completa linha de produtos autorais diferenciados para atender a projetos de residenciais, hotelaria, escritórios, clínicas, restaurantes, apartamentos decorados para construtoras entre outros.

A produção das peças é acompanhada por nossa equipe de desenvolvimento em todos os detalhes garantindo excelência em qualidade.

Fazemos produtos com medidas especiais e ampla gama de opções de acabamento, permitindo total personalização do projeto de acordo com o perfil do cliente.

ALESSANDRA DELGADO DESIGN has customized solutions for your projects.

Our complete collection of products is composed of a complete line of differentiated authorial products to meet the projects of residential, hospitality, offices, clinics, restaurants, decorated apartments for builders among others.

The production of the pieces is accompanied by our development team in every detail ensuring excellence in quality.

We make products with special measures and a wide range of finishing options, allowing full customization of the project according to the client's profile.

SOLUÇÕES COMPLETAS | **COMPLETE SOLUTIONS**



CARRINHOS, BARES, BUFFETS E APARADORES TROLLEYS, BARS, CREDENZA AND SIDEBOARDS	PAG. 4 17
SOFÁS, POLTRONAS E LUMINÁRIAS DE PISO COUCHES, ARMCHAIRS AND FLOOR LAMPS	PAG. 18 33
RACKS RACKS	PAG. 34 40
BANQUETAS E BANCOS STOOLS AND BENCHES	PAG. 41 51
MESAS DE JANTAR E CADEIRAS DINING TABLES AND CHAIR	PAG. 52 71
MESAS DE CENTRO E LATERAIS CENTER AND SIDE TABLES	PAG. 72 82
ESCRIVANINHAS E ESTANTES DESKS AND BOOKCASES	PAG. 83 86
COLEÇÃO RÊVE RÊVE COLLECTION	PAG. 87 98
PETIT DESIGN PARA CRIANÇAS PETIT DESIGN FOR CHILDREN	PAG. 99 100
COLEÇÃO OUTDOOR OUTDOOR COLLECTION	PAG. 101 104
ACABAMENTOS FINISHES	PAG. 105
CONTATOS CONTACT	PAG. 106

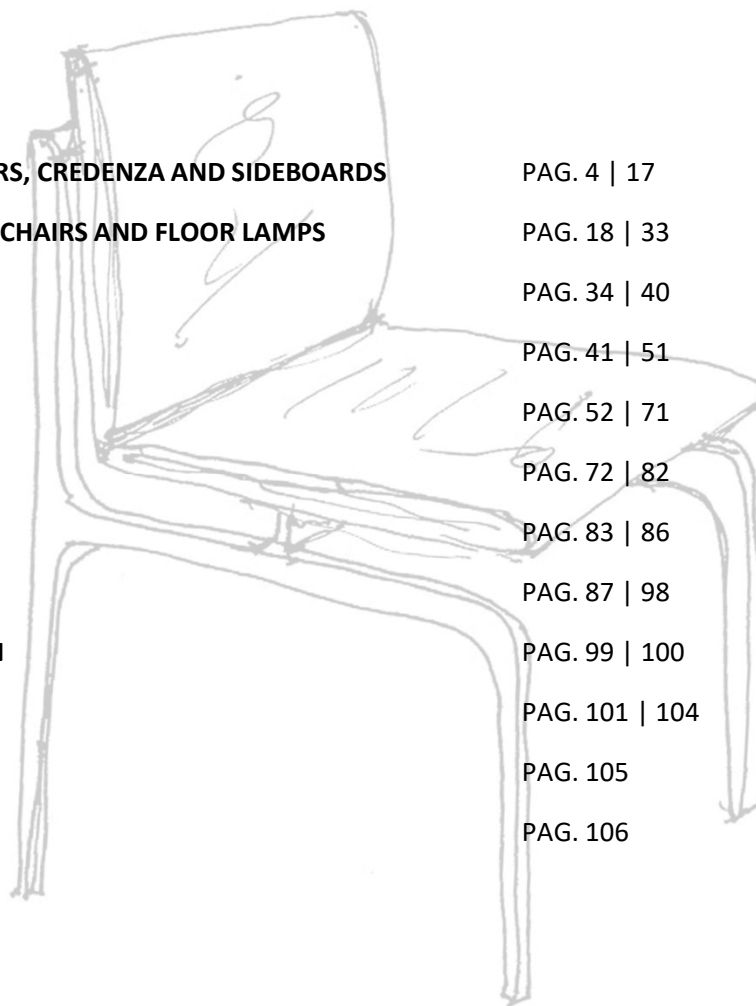

CARRINHOS, BARES, BUFFETS E APARADORES | **TROLLEYS, BARS, BUFFETS, SIDEBARDS**

Inspirada no maravilhoso legado de Jorge Zalszupin para o design brasileiro e sua linguagem única, Alessandra Delgado criou o carrinho Jorge. A estrutura em metal foi desenhada com movimento contínuo, leve e escultórico, trabalhada como se fosse uma dobradura.

Os tons de metal ouro e madeira pau ferro escolhidos como opções para esta peça trazem um toque vintage revisitado em linguagem moderna, conferindo ao Jorge uma atmosfera atemporal singular.

Inspired by Jorge Zalszupin's wonderful legacy for Brazilian design and his unique language, Alessandra Delgado created the Jorge trolley. The metal structure was designed with continuous movement, light and sculptural, worked as if it were a folding.

The shades of gold metal and ironwood chosen as options for this piece bring a vintage touch revisited in modern language, giving Jorge a unique timeless atmosphere.

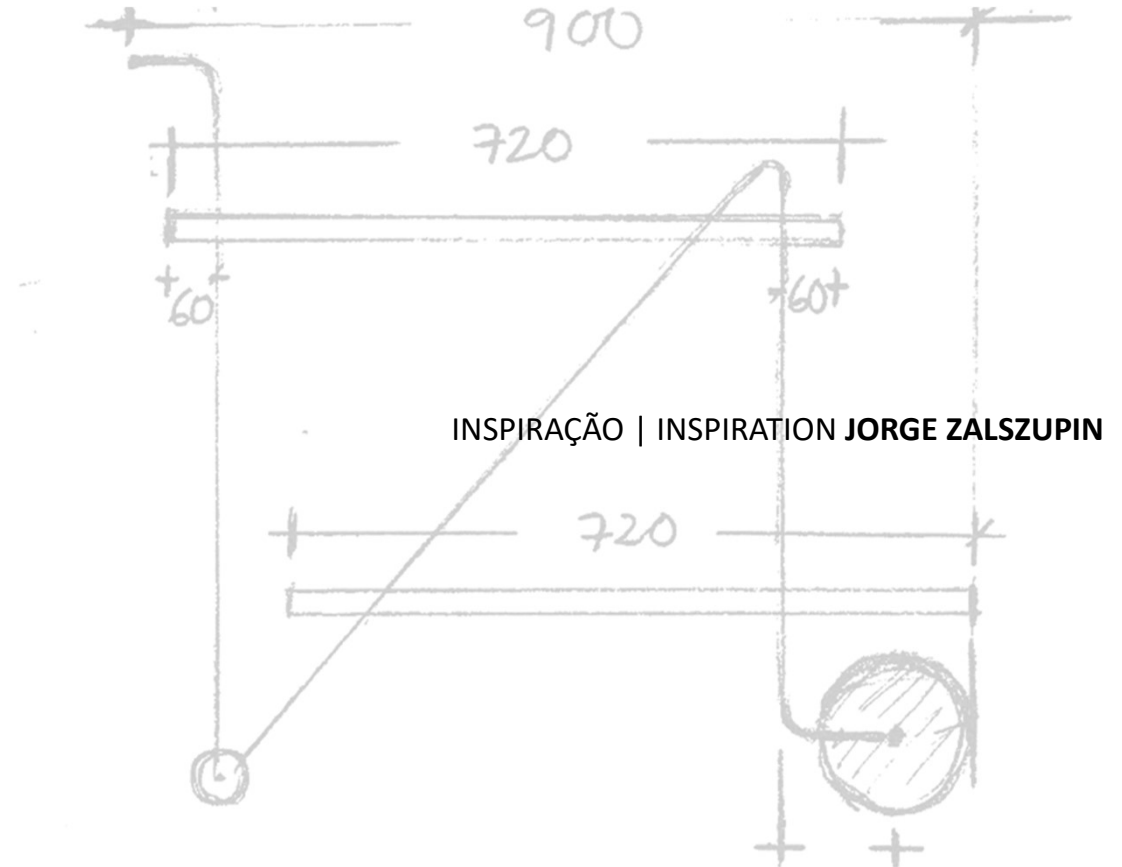

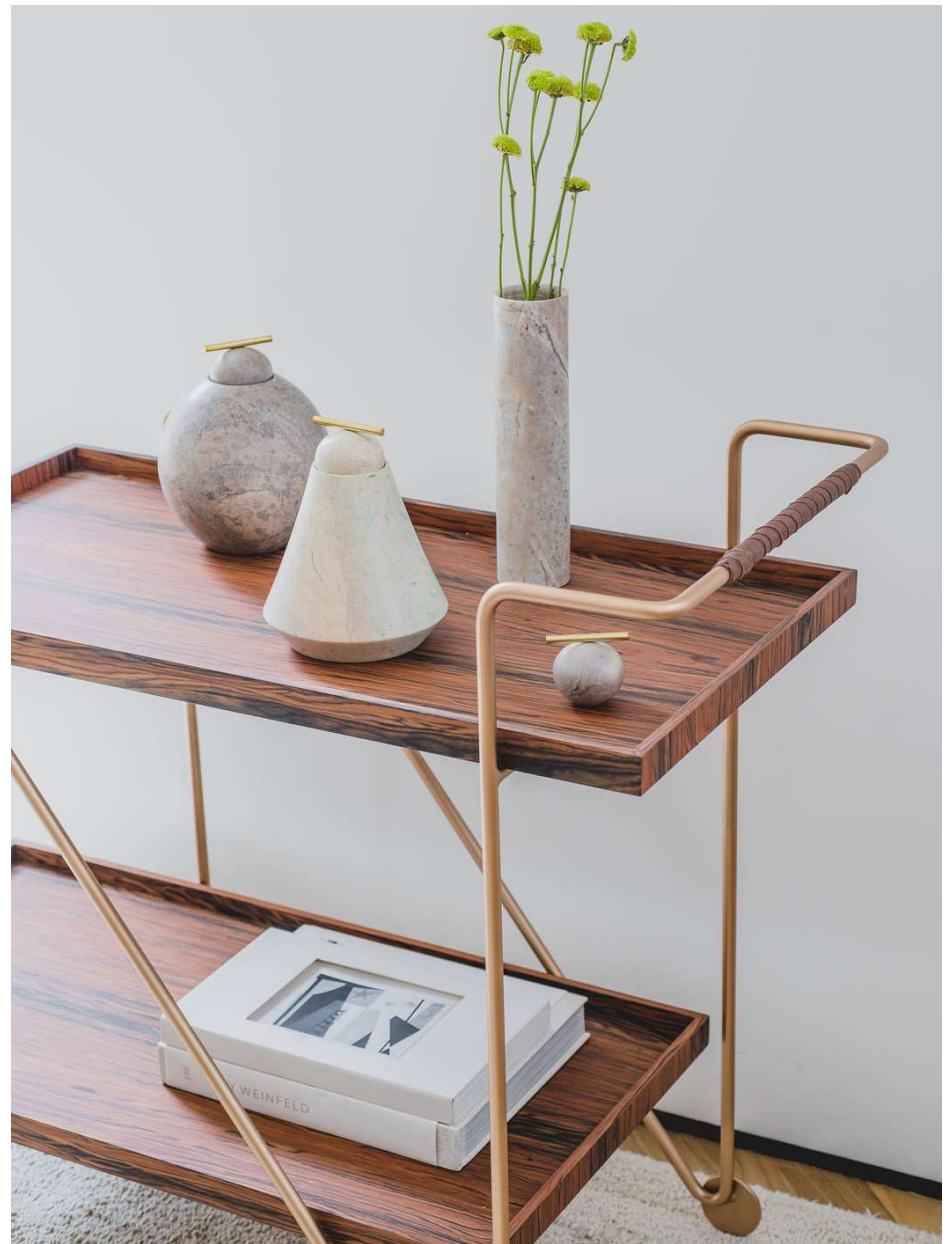

CARRINHO BAR | BAR CART JORGE

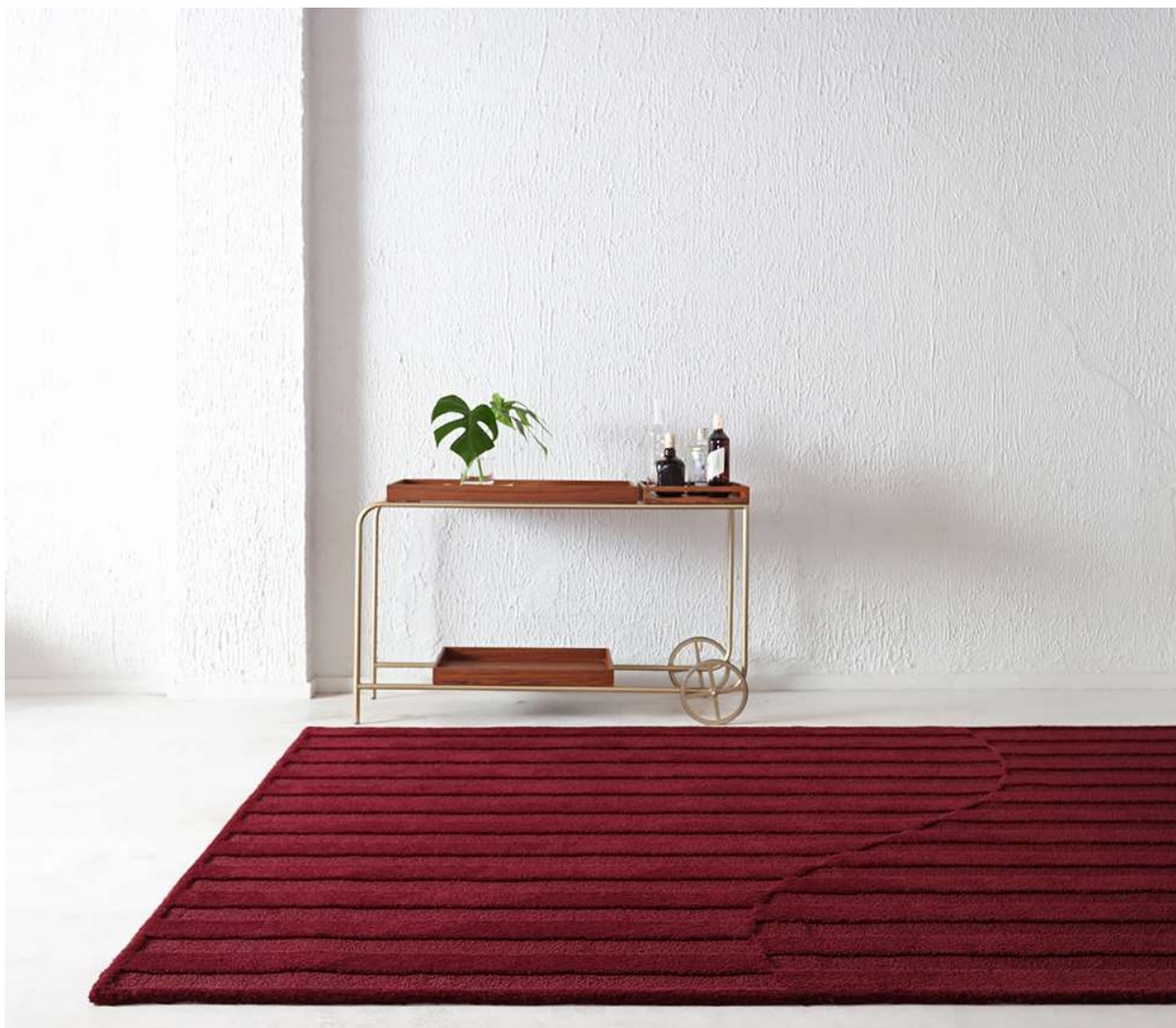



CARRINHO BAR | BAR CART **LOLA**



BAR | CREDENZA **BARDI**

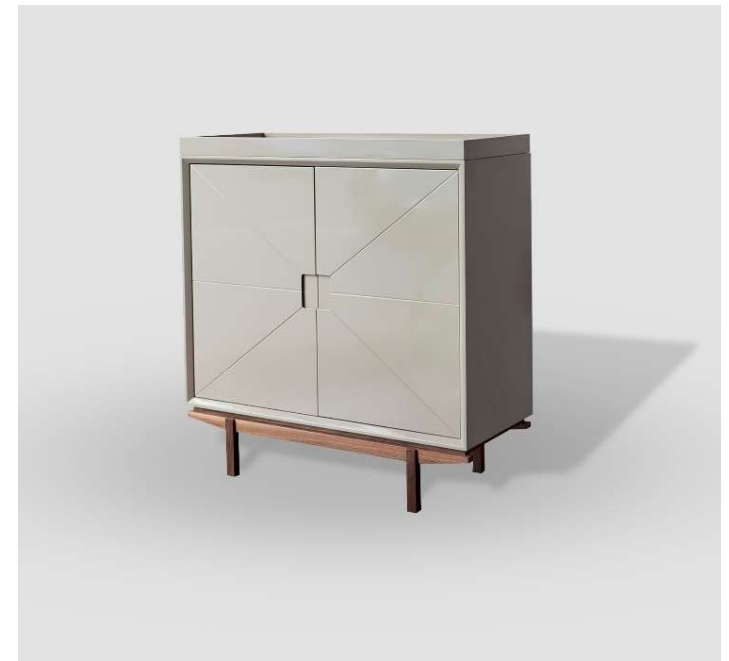



BUFFET | CREDENZA ATHENA



BUFFET | CREDENZA ETTO



BUFFET | CREDENZA LINA
APARADOR | SIDEBORD LINA



BUFFET | CREDENZA **BOSSA**
APARADOR | SIDEBBOARD **BOSSA**





APARADOR | SIDEBOARD **VOLPI**

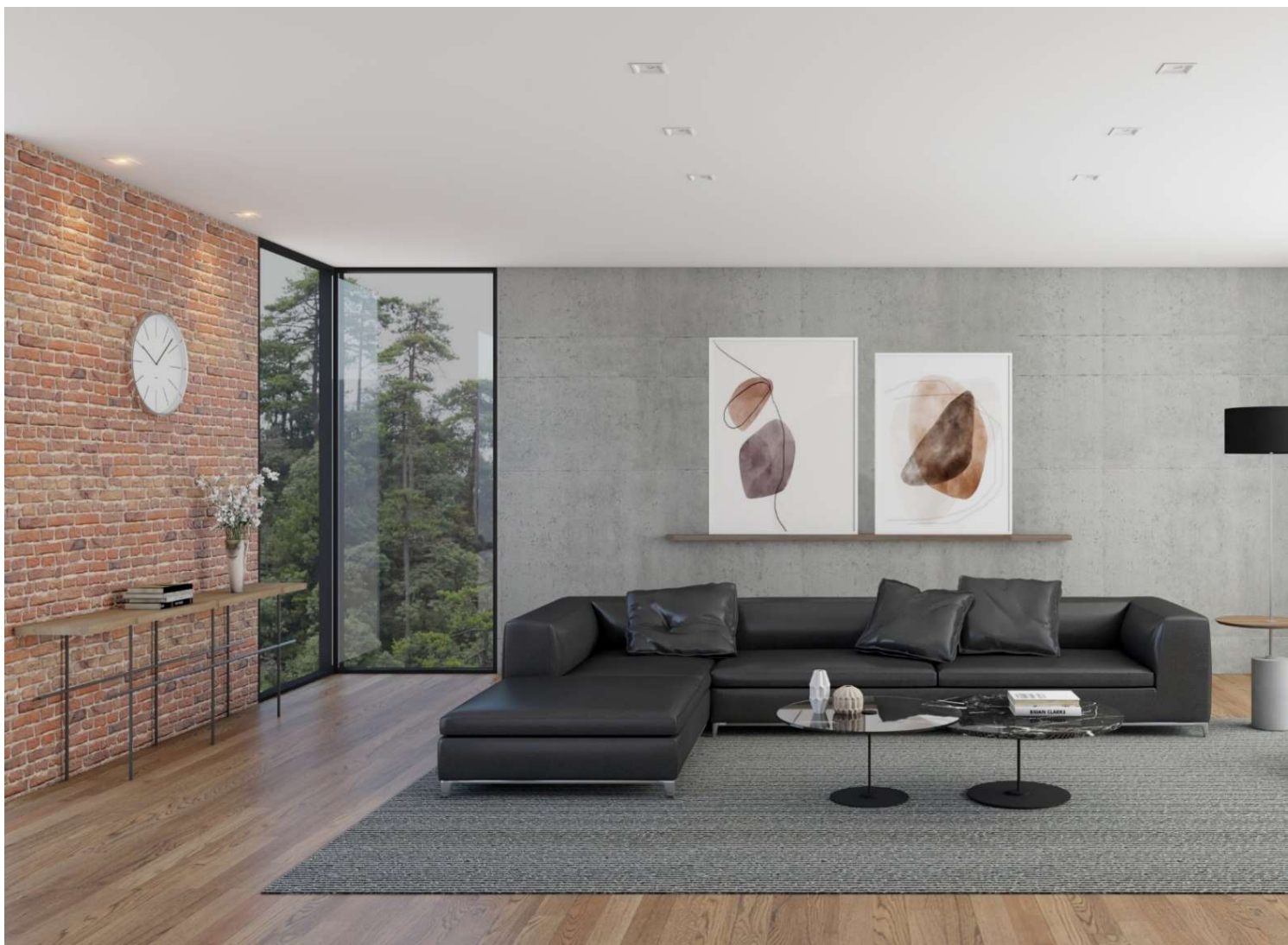

SOFÁS, POLTRONAS E LUMINÁRIAS DE PISO | **COUCHES, ARMCHAIRS AND FLOOR LAMPS**



SOFÁ | COUCHE NIE



SOFÁ MODULAR | COUCH **VAGUE**
TAPETE | RUG **OSCAR**
MESA LATERAL | SIDED TABLE **ZAL**



SOFÁ | COUCHE **LINA**
LUMINÁRIA DE PISO | FLOOR LAMP **GIRO**



SOFÁ | COUCHE **MAX**



SOFÁ | COUCHE MAX ILHA



SOFA | COUCHE **MAX MODULAR**



SOFA | COUCHE **MAX MODULAR**



POLTRONA | ARMCHAIR RÔ
TAPETE | CARPET OSCAR

Inspirada na arquitetura de Lina Bo Bardi, a poltrona Lina brinca com a leveza do vão livre do Masp e a presença marcante de seus pilares em concreto. Alessandra revisita o traço brutal e objetivo de Lina, traduzindo-o em elegante geometria.

A mistura de tecido e madeira trabalhada em detalhes de delicada marcenaria que abraça as almofadas traz aconchego e requinte. Pés em madeira sustenta o vão pousando delicadamente nas laterais, sobre a qual a poltrona e sua banqueta flutuam.

Inspired by the architecture of Lina Bo Bardi, the Lina armchair plays with the lightness of Masp's free span and the striking presence of its concrete pillars. Alessandra revisits Lina's brutal and objective trait, translating it into elegant geometry.

The mixture of fabric and wood worked in details of delicate joinery that embraces the cushions brings warmth and refinement. Wooden legs support the span landing delicately on the sides, on which the armchair and its stool float.

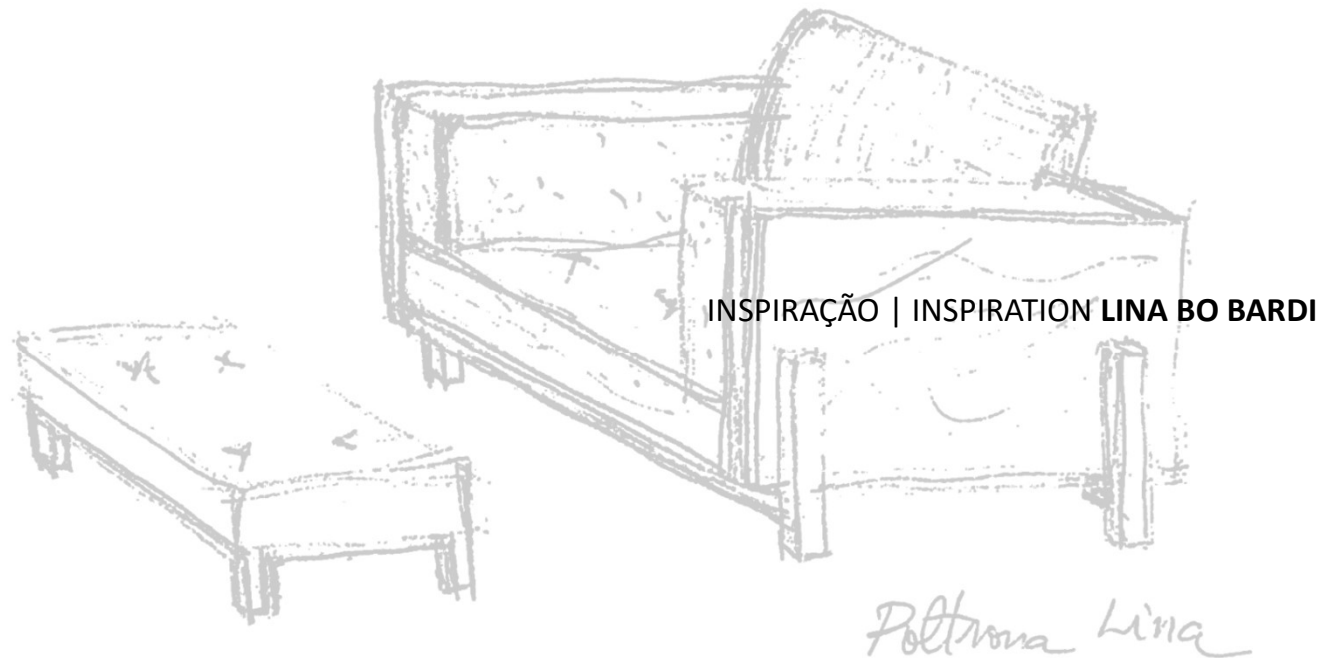



LUMINÁRIA DE PISO | FLOOR LAMP **RÓTULA**
POLTRONA | ARMCHAIR **LINA**
PUFF | OTTOMAN **LINA**

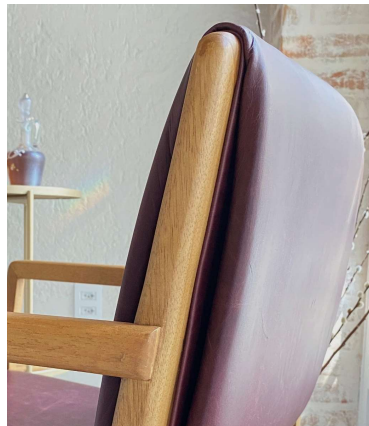

POLTRONA | ARMCHAIR JOCA
CARRO BAR | BAR CART JORGE
CARRO BAR | BAR CART LOLA



POLTRONA | ARMCHAIR **OSCAR**
MESA DE CENTRO | CENTER TABLE **HASTES**
LUMINÁRIA | FLOOR LAMP **GIRO**



POLTRONA | ARMCHAIR **BRUNA**



LUMINÁRIA DE PISO | FLOOR LAMP **GIRO**
POLTRONA | ARMCHAIR **JULIA**



POLTRONA | ARMCHAIR **LAURA**



RACKS | RACKS





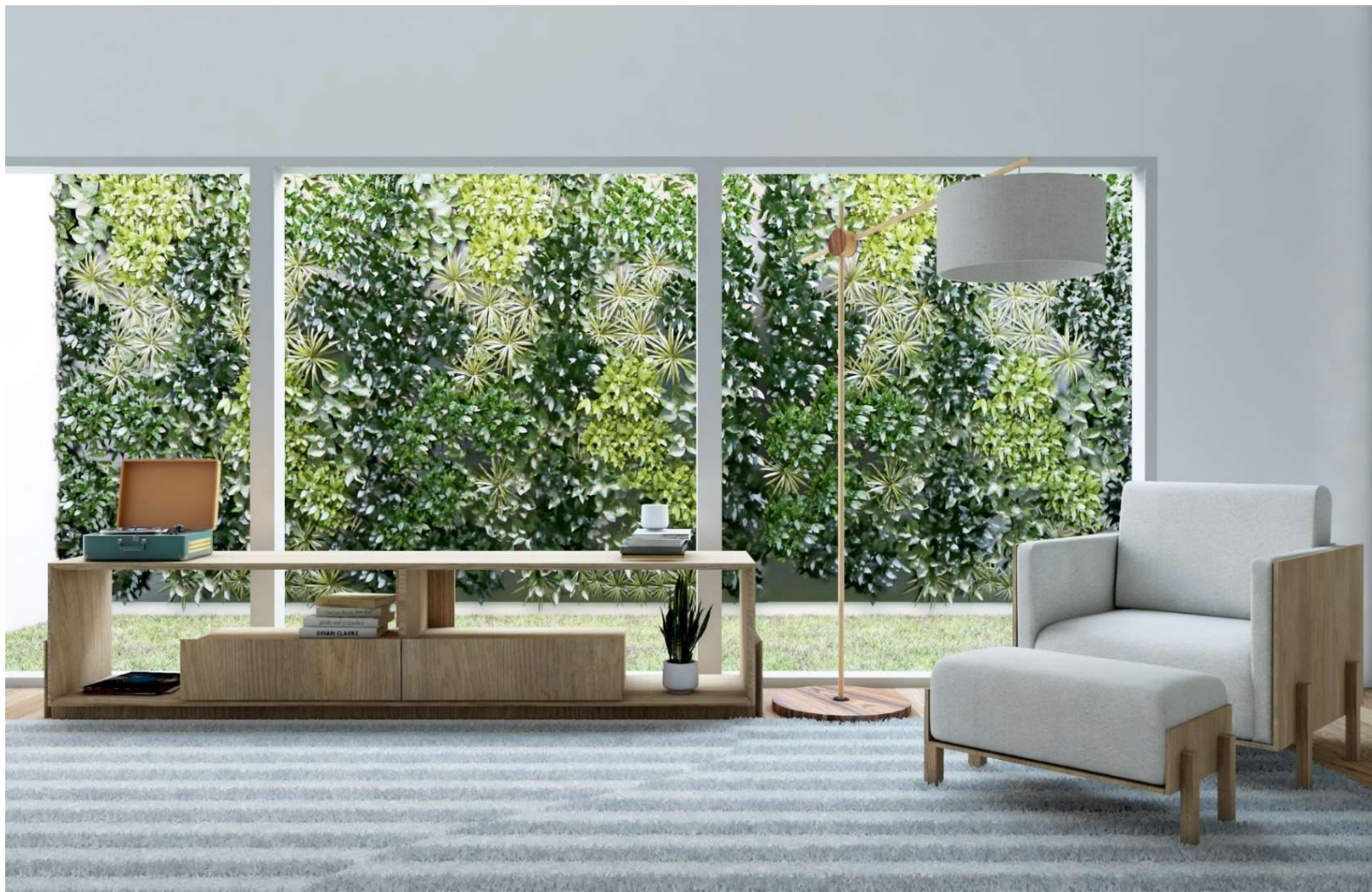



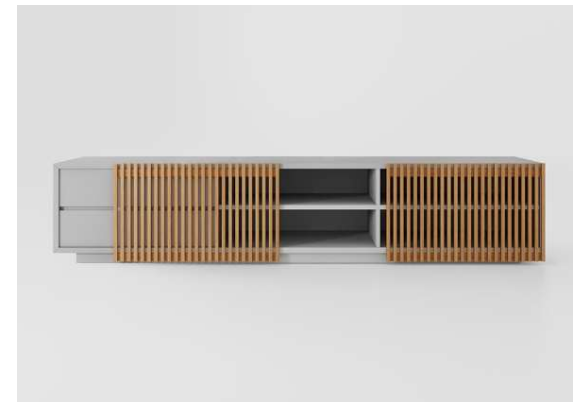

RACK | RACK **CADIZ**
TAPETE | CARPET **BRIZE**



BANQUETAS E BANCOS | **STOOLS AND BENCHES**

A madeira é um elemento muito presente nas criações de Alessandra. Ela aparece de nas mais variadas inspirações, exclusiva ou acompanhada por metal, vidro, tecido, couro, concreto.

Escolher a madeira adequada para cada projeto, com suas texturas, nuances e desenhos permite trazer dá vida e personalidade única ao móvel, trazendo também o marcante traço atemporal que é identidade da marca.

Wood is a very present element in Alessandra's creations. It appears in the most varied inspirations, exclusive or accompanied by metal, glass, fabric, leather, concrete.

Choosing the right wood for each project, with its textures, nuances and designs allows to bring life and unique personality to the furniture, also bringing the striking timeless trait that is the brand's identity.



INSPIRAÇÃO NATUREZA | INSPIRATION NATURE





BANCO | BENCH **UNO**
BANCO | BENCH **DUO**
BANCO | BENCH **TREE**

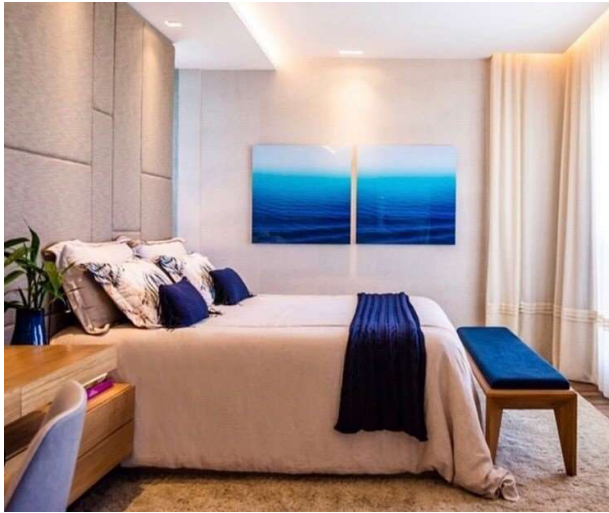

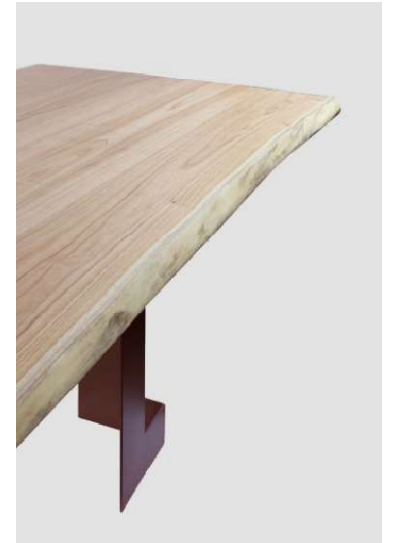

BANCO | BENCH PLANOS





BANQUETA COM ENCOSTO | STOOL WITH BACKREST **BRUNA**



BANQUETA | STOOL LAURA



BANQUETA | STOOL OSCAR



BANQUETA | STOOL JULIA

MESAS DE JANTAR E CADEIRAS | **DINING TABLES AND CHAIR**

Alessandra desenvolveu esta coleção a partir da experiência da dobra do aço, onde a leveza das formas faz com que pareçam flutuar.

Os acabamentos exclusivos para os metais abrangem uma gama de tons exclusivos, com opções como ouro leve, marrom corten, titânio e preto que mesclados a tecidos e madeira também selecionados a dedo dão elegância única à coleção.

Alessandra developed this collection from the experience of bending steel, where the lightness of the shapes makes them appear to float.

The unique finishes for the metals cover a range of exclusive shades, with options such as light gold, corten brown, titanium and black that mixed with handpicked fabrics and wood give the collection unique elegance.



INSPIRAÇÃO LEVEZA | INSPIRATION LIGHTNESS

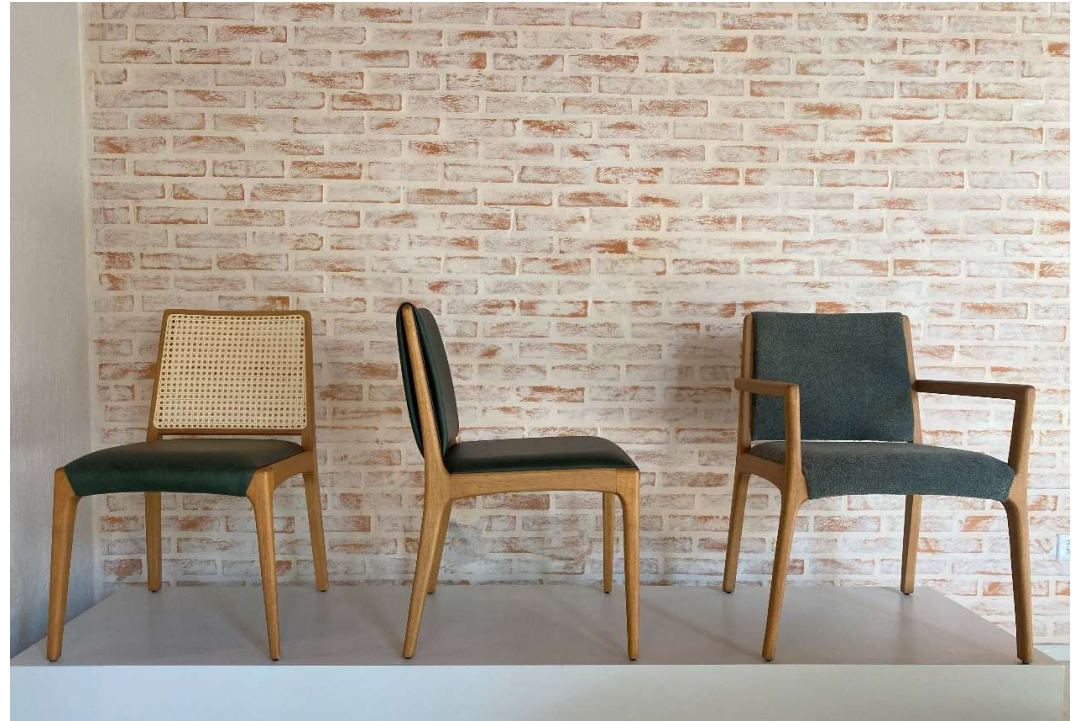

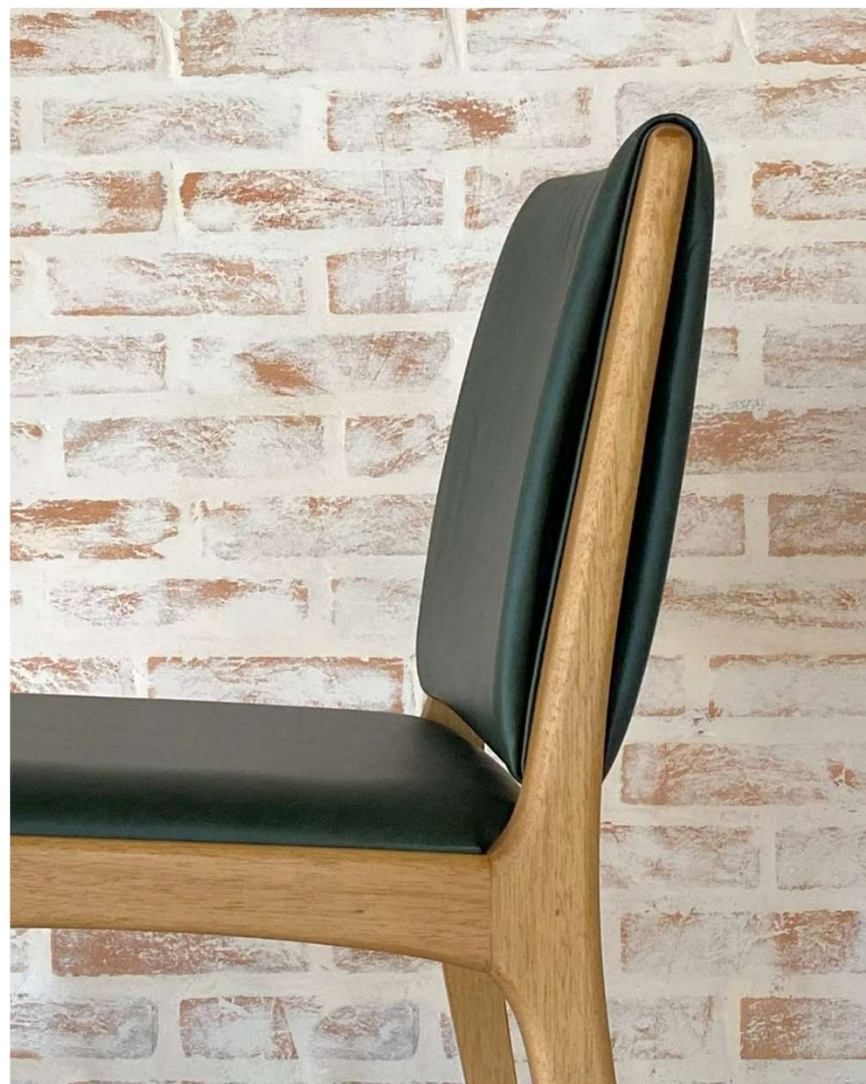

CADEIRA | CHAIR JOCA
CARRO BAR | BAR CART LOLA

Inspirada em Lilly Reich, que foi uma renomada designer de interiores e arquiteta alemã cujo trabalho teve um impacto significativo na história do design moderno.

Alessandra transforma essa referência numa elegante e leve cadeira em madeira, com traços delicados que equilibram harmonia entre a forma e função.

Inspired by Lilly Reich, a renowned German interior designer and architect whose work had a significant impact on modern design history.

Alessandra transforms this into a beautiful, light wooden chair, with delicate features where she finds harmony between form and function, embodied by minimalist lines



INSPIRAÇÃO | INSPIRATION CADEIRA LILLY





CADEIRA | CHAIR LILLY
TAPETE | RUG BRISE
RACK ATHENA

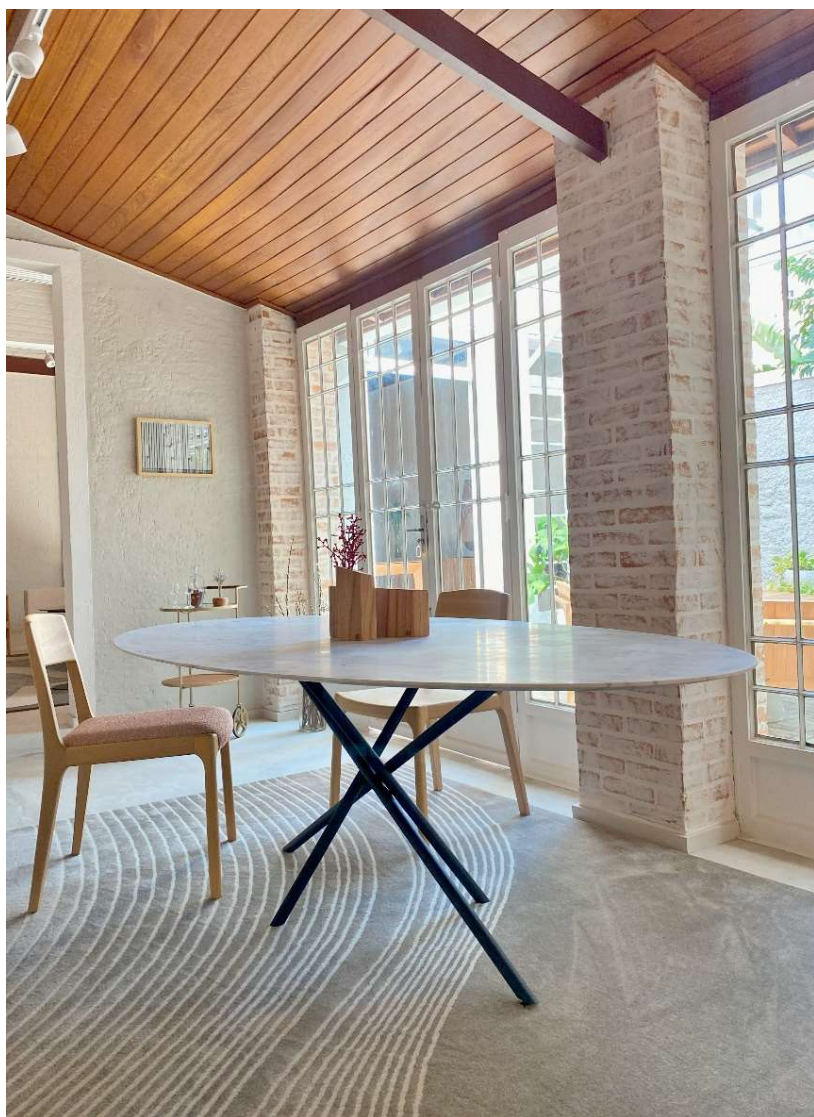

CADEIRA | CHAIR LILLY
MESA DE JANTAR | DINING TABLE HASTES
TAPETE | RUG PAULICEIA



CADEIRA COM BRAÇOS | CHAIR WITH ARMRESTS **BRUNA**
CADEIRA | CHAIR **BRUNA**



MESA DE JANTAR OVAL | OVAL DINING TABLE **PILAR**
CADEIRA | CHAIR **LAURA**

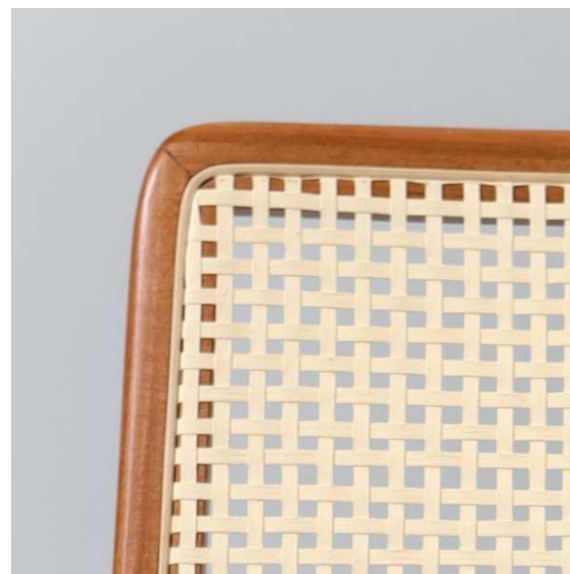

MESA DE JANTAR REDONDA | ROUND DINING TABLE **HASTES**
CADEIRA | CHAIR **JULIA**



MESA DE JANTAR | DINING TABLE **ANAMBÉ**
CADEIRA | CHAIR **JULIA**

A mesa de jantar Planalto foi inspirada nas curvas do mestre Niemeyer. Sua criação remete às construções do arquiteto que tornaram única a arquitetura de Brasília, onde a elegância escultórica de seu traço se destaca de forma contundente

Alessandra cria na mesa Planalto um encontro de curvas assimétricas que se entrelaçam formando uma marcante escultura em madeira.

The Planalto dining table was inspired by the curves of the master Niemeyer. Its creation refers to the architect's constructions that made the architecture of Brasilia unique, where the sculptural elegance of his trait stands out in a striking way

Alessandra creates in the Planalto table a meeting of asymmetrical curves that intertwine forming a striking wooden sculpture.



INSPIRAÇÃO | INSPIRATION **OSCAR NIEMEYER**



MESA DE JANTAR OVAL | OVAL DINING TABLE **PLANALTO**
MESA DE JANTAR REDONDA | ROUND DINING TABLE **PLANALTO**
CADEIRA | CHAIR **OSCAR**



MESA DE JANTAR | DINING TABLE **PLANOS**



MESA DE JANTAR QUADRADA | SQUARE DINING TABLE **PLANOS**
MESA DE JANTAR REDONDA | ROUND DINING TABLE **PLANOS**
CADEIRA COM BRAÇOS | CHAIR WITH ARMS **JULIA**



MESA DE JANTAR REDONDA | ROUND DINING TABLE **PILAR**
MESA DE JANTAR OVAL | OVAL DINNING TABLE **PILAR**
CADEIRA COM BRAÇOS | CHAIR WITH ARMS **LAURA**



MESA DE JANTAR | DINING TABLE **VOLPI**
CADEIRA | CHAIR **JULIA**



MESA DE JANTAR | DINING TABLE **VOLPI**
RACK **ATHENA**
TAPETE | RUG **BRISE**



MESA DE JANTAR | DINNING TABLE **MARIA**

MESAS DE CENTRO E LATERAIS | **CENTER AND SIDE TABLES**

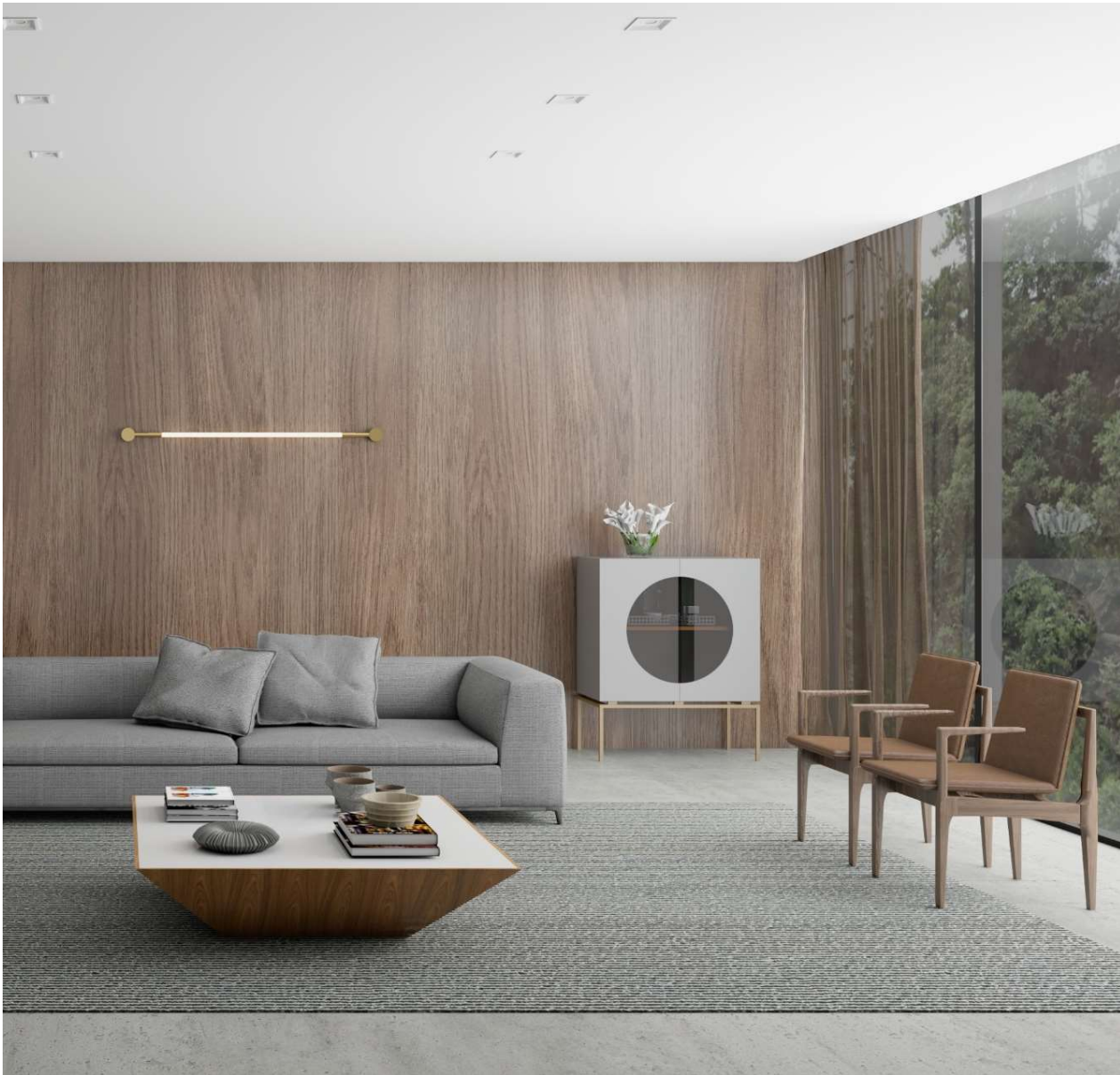

MESA DE CENTRO | CENTER TABLE **GIZÉ**



MESA DE CENTRO | CENTER TABLE **NICHOS**



MESA LATERAL | SIDE TABLE **HASTES**
MESA DE CENTRO | CENTER TABLE **HASTES**



MESA LATERAL | SIDE TABLE **APARAS**
MESA DE CENTRO | CENTER TABLE **APARAS**

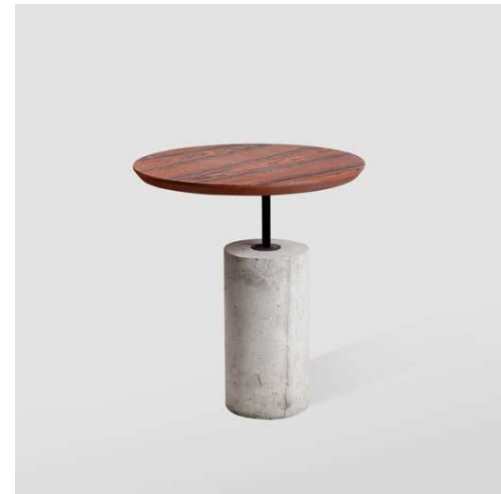
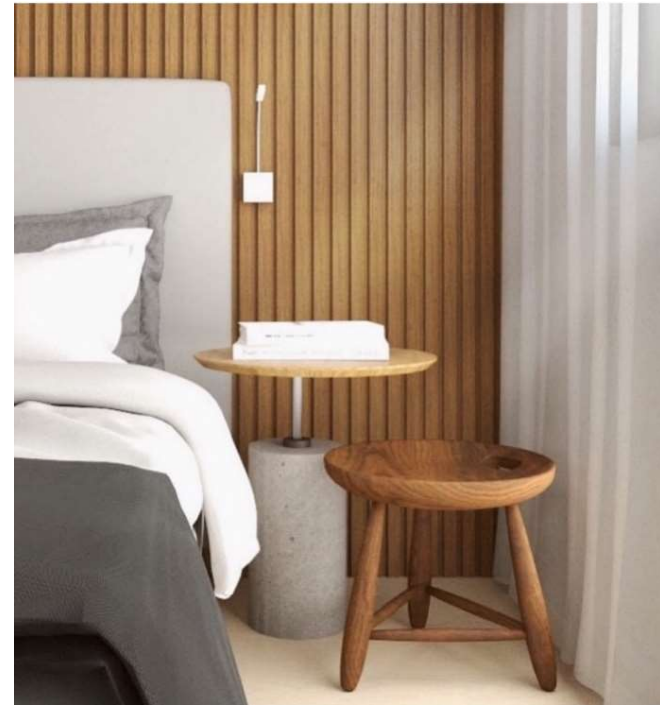
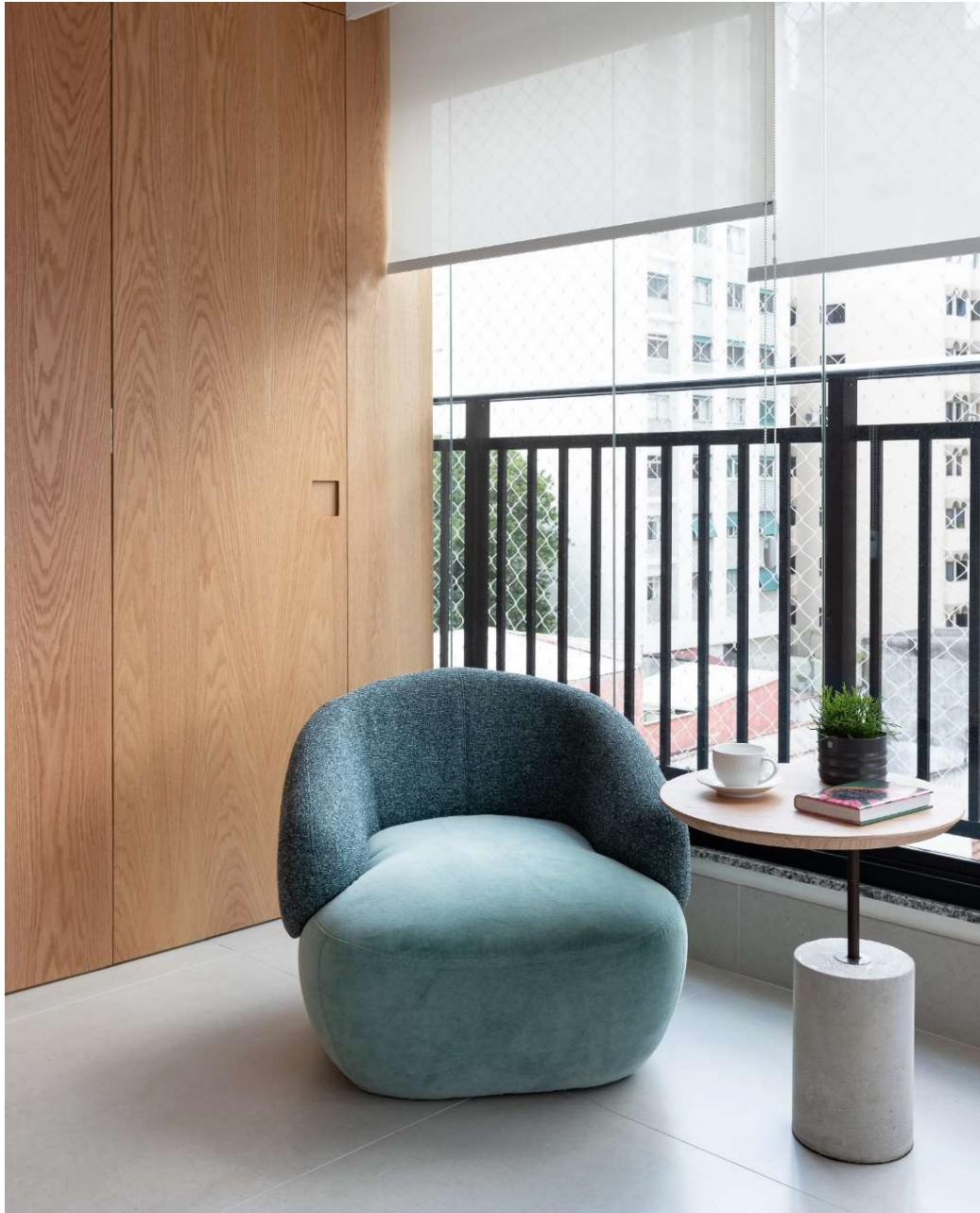

MESA LATERAL | SIDE TABLE **GIRO**



MESA DE CENTRO | CENTER TABLE **CÍRCULOS**
MESA LATERAL | SIDE TABLE **CÍRCULOS**



MESA DE CENTRO | CENTER TABLE **VOLPI**
MESA LATERAL | SIDE TABLE **VOLPI**



MESA LATERAL | SIDE TABLE **TORA**



MESA DE CENTRO | CENTER TABLE **PIN**
MESA DE CENTRO | CENTER TABLE **ELIPSE**



MESA DE CENTRO | CENTER TABLE **ZAL**
MESA LATERAL | SIDE TABLE **ZAL**

ESCRIVANINHAS E ESTANTES | **DESKS AND BOOKCASES**



ESCRIVANINHA | DESK **BOSSA**
ESTANTE | BOOKCASE **LINHAS**



APARADOR E ESCRIVANINHA | SIDEBORD AND DESK **VOLPI**
ESTANTE | BOOKCASE **MONDRIAN**
ESTANTE | BOOKCASE **LINHAS**



ESTANTE | BOOKCASE EQUIS
ESCRIVANINHA | DESK PLANOS

Rêve vem do francês "sonho".

A **Coleção Rêve** foi inspirada em mulheres que mudaram o universo feminino e a moda. Essas grandes estilistas foram revolucionárias com suas obras, que desafiaram imposições de comportamento de sua época e quebraram paradigmas, tendo influência fundamental na emancipação da mulher e seu papel na sociedade.

A coleção traz na riqueza das costuras, nos entalhes de madeira e delicadeza na escolha de materiais, referências ao universo da moda. Sendo Paris a capital mundial da moda, batizei carinhosamente a coleção à francesa.

Rêve comes from the French for "dream".

The **Rêve Collection** was inspired by women who changed the female universe and fashion. These great designers were revolutionary with their work, which challenged the impositions of behavior of their time and broke paradigms, having a fundamental influence on the emancipation of women and their role in society.

The collection brings the richness of the seams, the wood carvings and the delicacy in the choice of materials, references to the fashion universe. As Paris is the world capital of fashion, I affectionately named the collection French style.



Coleção **RÊVE**





CAMA | BED ATHENA
CABECEIRA | HEADBOAR ATHENA
CABECEIRA ATHENA



MESA DE CABECEIRA | BEDSIDE TABLE **GABIE** | **GABIE II**





CABECEIRA | HEADBOAR **GABRIELLE**



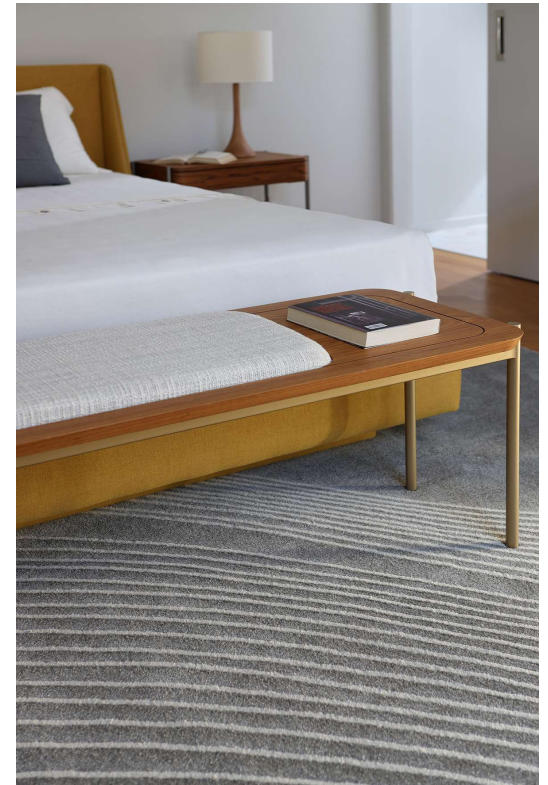

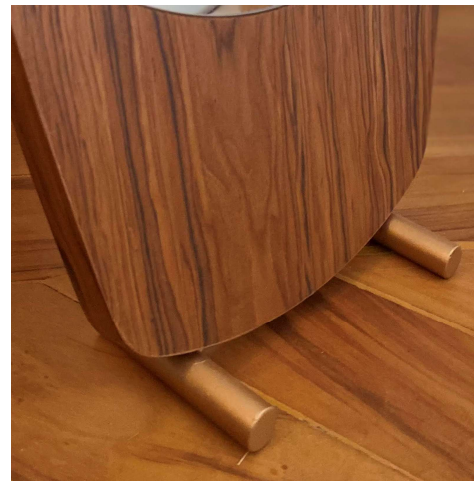



APARADOR | SIDEBBOARD VÉRTICE
ESPELHO | MIRROR OLHO



APARADOR | SIDEBOARD **VÉRTICE**
CÔMODA | DRESSER **MARY**
ESPELHO | MIRROR **OLHO**



A coleção Petit Design traz as criações de Alessandra em miniatura para os pequenos.

São cadeiras, banquetinhas, penteadeira, escrivaninha, mesinha e carrinho de chá, uma brincadeira com design.

The Petit Design collection brings Alessandra's creations in miniature for the little ones.

They are chairs, stools, dressing table, desk, table and tea cart, a play with design.





LINHA PETIT DESIGN | PETIT DESIGN COLLECTION

Linha outdoor, a linha de móveis para espaços de área externa coberta.

Com materiais seleccionados com alta performance em durabilidade.

Outdoor line, the furniture line for covered outdoor spaces.

Made from selected materials with high durability performance.



COLEÇÃO OUTDOOR | OUTDOOR COLLECTION



CADEIRA | CHAIR **OSCAR OUTDOOR**
MESA | TABLE **ANAMBÉ OUTDOOR**



BANCO | BANCK VOLPI OUTDOOR
MESA | TABLE VOLPI OUTDOOR

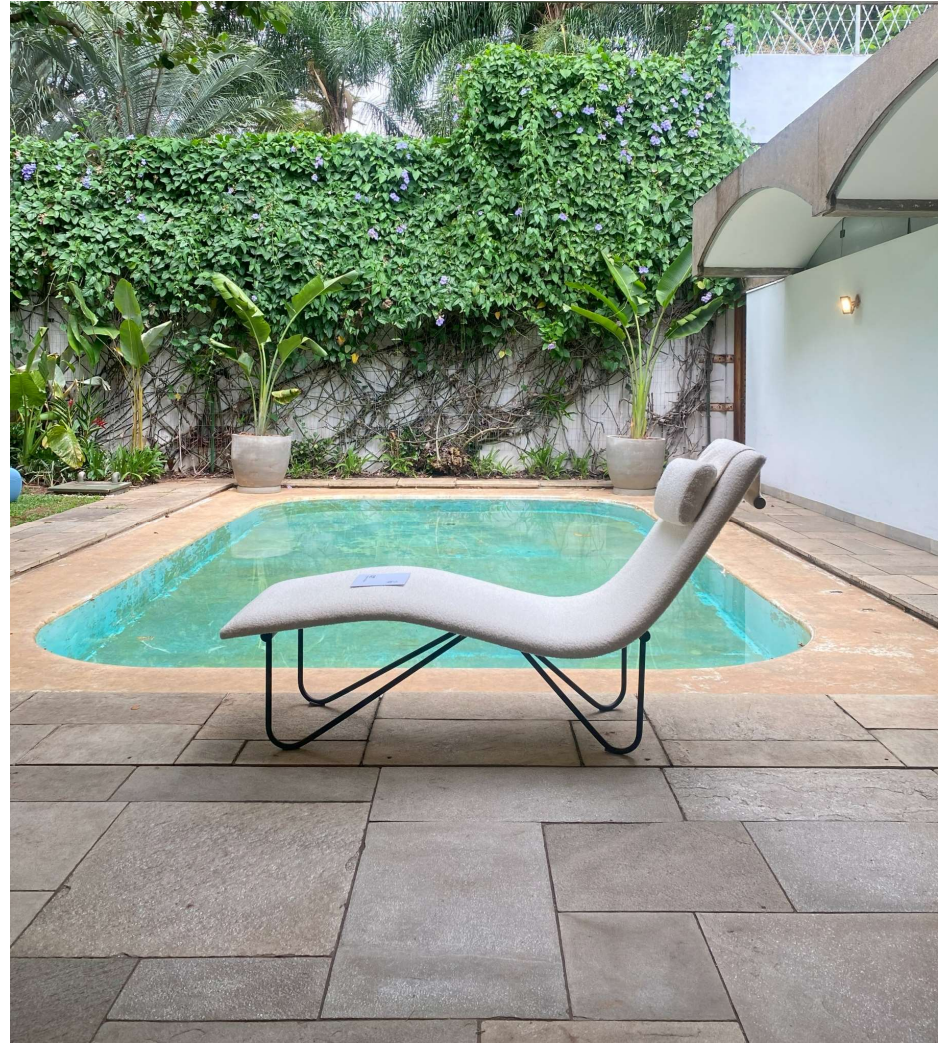

A collage of various material samples including wood, metal, straw, fabric, and leather. The samples are arranged in a layered, overlapping fashion. On the left, there is a vertical strip of light-colored wood grain. To its right is a large, solid brown leather-like panel. In the center, four rolls of material are stacked vertically, showing different colors: silver, gold, dark brown, and black. To the right of these rolls is a rectangular panel of woven straw or bamboo in a diamond pattern. Below the straw panel is a vertical strip of dark wood grain. At the bottom center, there is a large, dark blue fabric sample with a visible texture and folds.

Com uma gama exclusiva de opções entre tons e desenhos de madeira, cores de metais, texturas de palhas, tecidos e couros, as criações da marca podem ser customizadas para seu projeto deixando-o com identidade única.

With an exclusive range of options between wood tones and designs, metal colors, straw textures, fabrics and leathers, the brand's creations can be customized to your project leaving it with a unique identity.

TRANSFORMANDO SONHO EM REALIDADE | TURNING **DREAM** INTO REALITY



 WWW.ALESSANDRADELGADODESIGN.COM

 [ALESSANDRA.DELGADO.DESIGN](https://www.instagram.com/ALESSANDRA.DELGADO.DESIGN)

 TELEFONE: +55 11 99834-5572

 CONTATO@ALESSANDRADELGADODESIGN.COM